

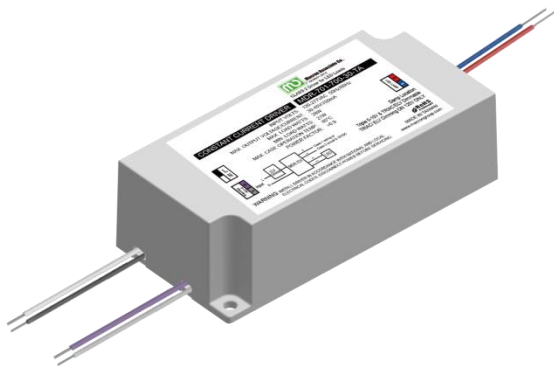

# SPECIFICATIONS

## MDR-701-400-20-TA

GEN 5



Note-

- 1. UL file: E340871



### Protection

- Auto-reset electronic short circuit
- Overload protection
- Thermal protection
- Class 2

### Mechanical and Thermal

Dimensions L 3.307" × W1.575" × H 0.992"

Lead Wire Length 6" (Standard)

Max. Case Operation Temp. 80°C

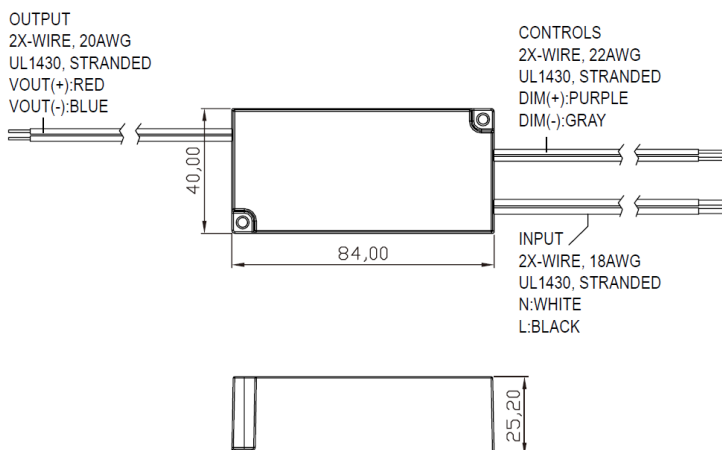

### Features

- ✓ 0-10V & TRIAC/ELV Dimmable in 1
- ✓ Compact size
- ✓ Low profile
- ✓ Constant Current Output
- ✓ Active Power Factor
- ✓ Class 2 compliance
- ✓ 5 Year Warranty
- ✓ Universal Input (Dim on 120V For TRIAC/ELV & 120/277V For 0-10V)
- ✓ Ultra Slow Ripple

### Environmental Specifications

- MTBF >100,000 hrs
- RoHS Compliant
- Lead Free SMT process
- Power Factor Correction / Low Load
- FCC Part 15 Class B compliant

### Wiring Diagram

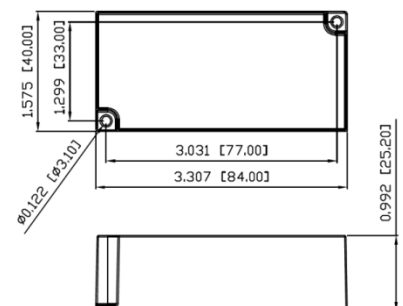
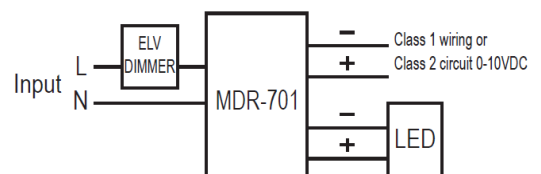

\* Dimension in Inch / metrics

Macron Associate Co. – Power Supply Team

NO.352, Perng-Yi Road, Taiping, Taichung, Taiwan 411

TEL: 886-4-22708357 FAX: 886-4-22767307 Email: macron@macrongroup.com

A0920

## Input - specification

	Units	Minimum	Typical	Maximum	Notes
Input Voltage Range(Vin)	Vac	108	120-277	304	
Input Frequency Range	Hz	50	60	63	
Input Power	W		20		
Power Factor(PF)		0.9	>0.9		>80% Load
Input Current	A	-	-	0.16A@120VAC 0.10A@277VAC	
Inrush Current	A			4 A peak	According to IEC 60555
Total Harmonics Distortion (THD)				20%	1. At nominal input voltage and nominal LED voltage 2. Measure at full load
Efficiency		-	>81%	-	Efficiency is measured after driver has thermally stabilized + full load
Isolation	Meet UL1310/UL8750 for class 2 isolation power supply				

## Output - specification

	Units	Minimum	Typical	Maximum	Notes
Output Voltage(V out)	Vdc	30		40	
Output Current(I out)	mA		400		
Output Current Tolerance	%		±3		
Output Ripple Current	<20% peak-to-peak of 400mA				$\leq 20\%$ pk-to-pk of the rated output current for all models with Vout max $\geq 32V$ $\leq 50\%$ pk-to-pk of the rated output current for all models with Vout max $\leq 30V$ At nominal LED voltage and nominal input voltage without dimming
Dimming Range	%	1% for TRIAC / ELV < 1 % for 0-10V 1%=0.7 Vac		100%	Please refer to Dimmer compatibility list
Start-up Time	ms		300		With nominal LED voltage and without dimmer attached
			350		With nominal LED voltage, with an recommended dimmer attached(see dimmer compatibility list) and at the full dimming conduction angle
Operation Case Temperature	°C	-30		80°C	

## EMC / Protection / Compliance

Conducted and Radiated EMI		FCC CFR Title 47 Part 15 Class B and EN55022(CISPR 22) Class B compliant			
Immunity Compliance	ESD (Electrostatic Discharge)	IEC61000-4-2	6 kV contact discharge, 8 kV air discharge, level 3		
	Electrical Fast Transient	IEC61000-4-4	±2 kV on AC power port for 1 minute, ±1kV on signal/control lines		
	Surge	IEC61000-4-5	±1kV line to line/±2kV line to earth on AC power port, ±0.5kV for outdoor cables		
Transient Protection	Ring Wave		ANSI/IEEE c62.41-1-2002 & c62.41-2-2002 category A, 2.5kV ring wave		

## THD of the driver VS Power Output (W) :

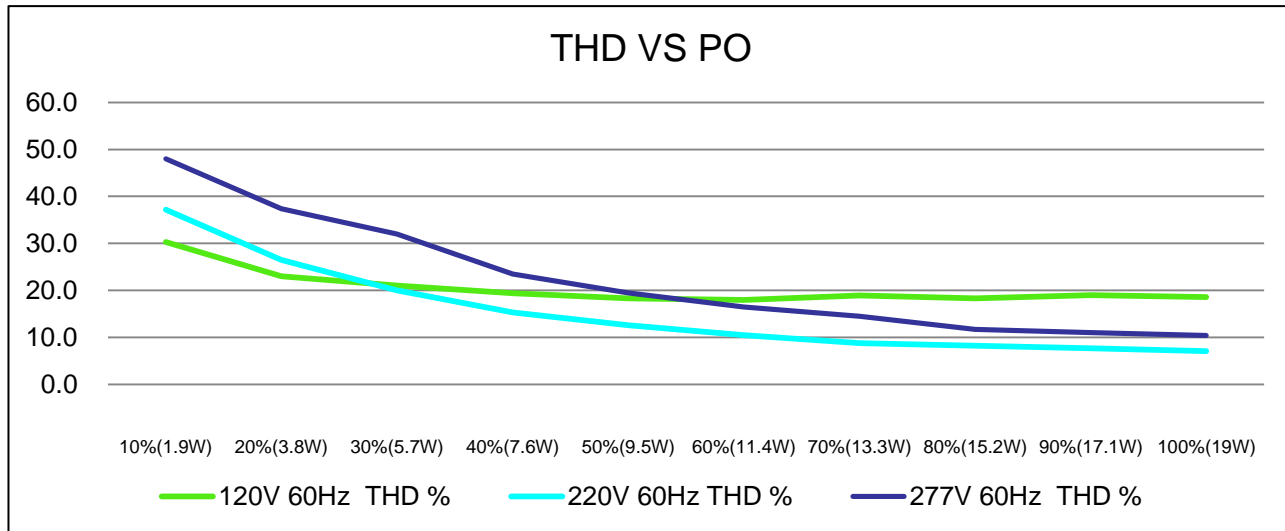

## Efficiency of the driver VS Power Output (W) :

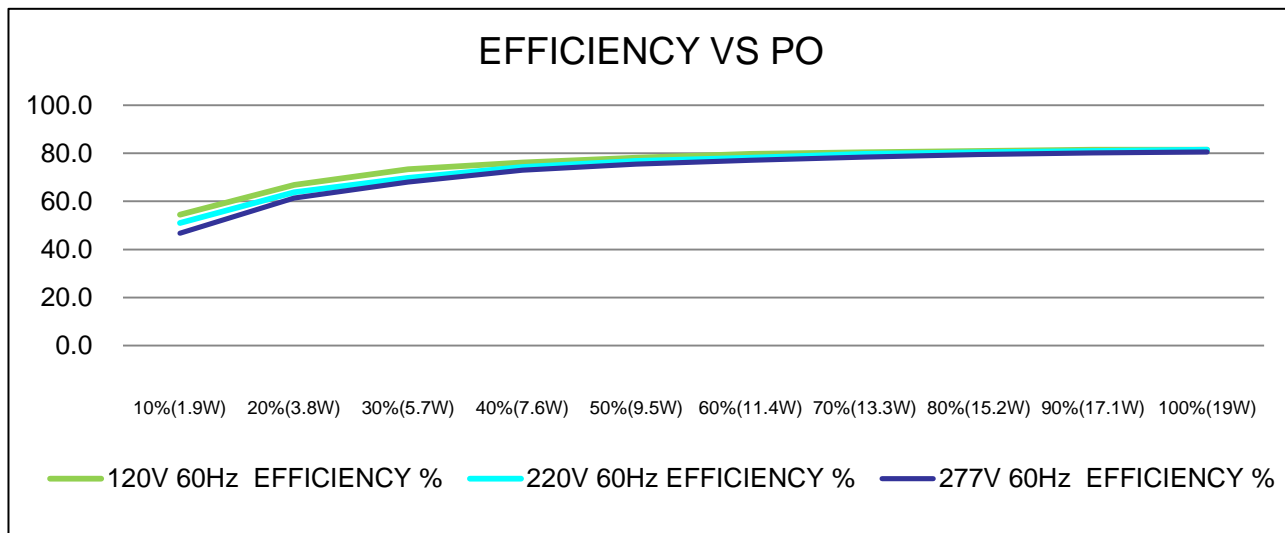

## Efficiency of the driver VS Power Output (W) :

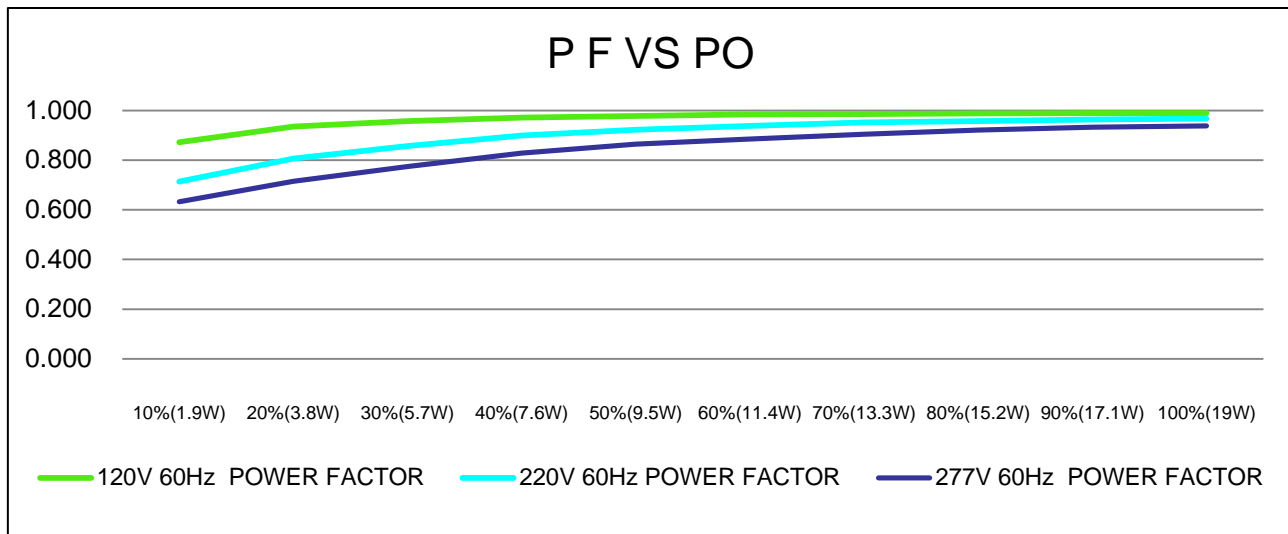

## Dim Voltage(V) VS Output Current

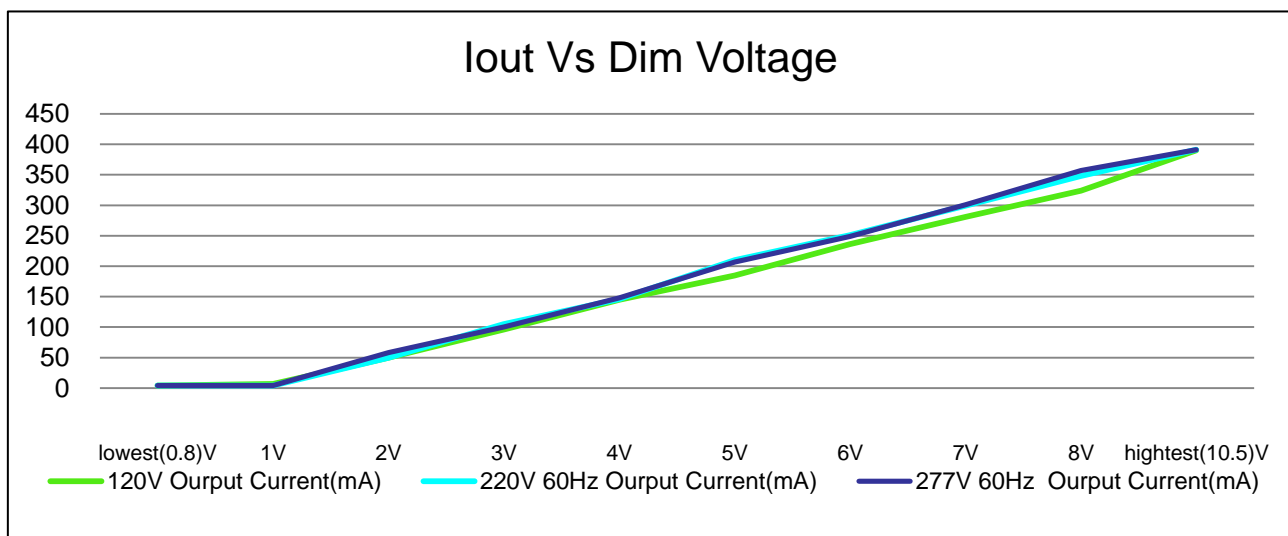

## Driver Lifetime V.S Driver Case Temperature

### Driver Lifetime V.S Driver Case Temperature

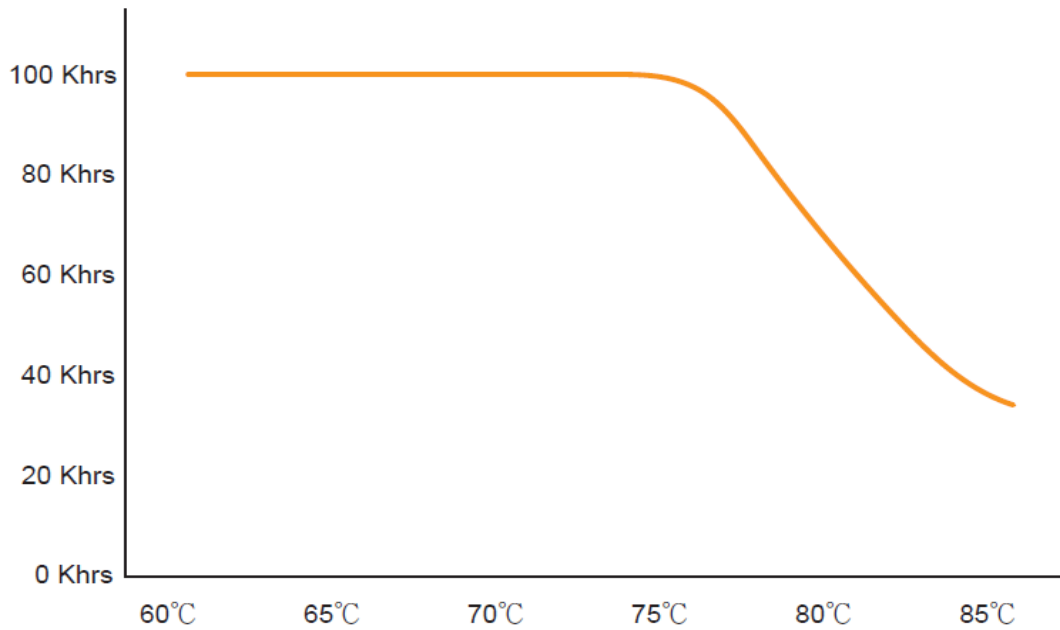

Macron Associate Co. – Power Supply Team

NO.352, Perng-Yi Road, Taiping, Taichung, Taiwan 411

TEL: 886-4-22708357 FAX: 886-4-22767307 Email: [macron@macrongroup.com](mailto:macron@macrongroup.com)