

SPECIFICATIONS

Features

- Work for most 3-wire/ 2-wire dimmer
- Compact size
- Low profile
- Constant Current Output
- Active Power Factor
- Class 2 compliance
- 5 Year Warranty
- Bottom Wire Exits
- Selectable Current
- Universal Input (120-277V, Dim on 120V)
- Ultra Slow Ripple

Wiring Diagram

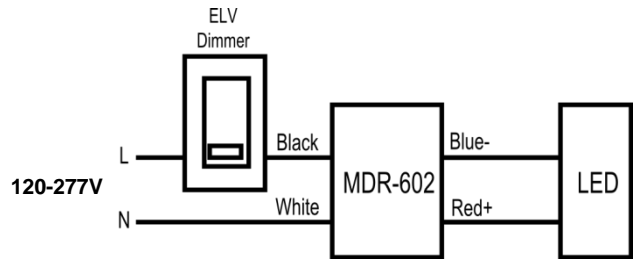

Mechanical and Thermal

Dimensions L 3.878" × W2.047" × H 1.171"
 Lead Wire Length 6" (Standard)
 Max. Case Operation Temp. 80°C

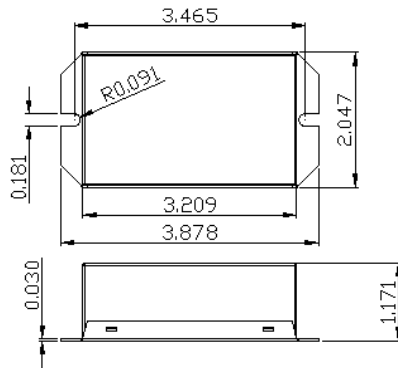

* Dimension in Inch

Protection

- Auto-reset electronic short circuit
- Overload protection
- Thermal protection
- Class 2

Environmental Specifications

- MTBF >100,000 hrs
- RoHS Compliant
- Lead Free SMT process
- Power Factor Correction / Low Load
- FCC Part 15 Class B compliant



Note –

1. UL file No. : E340871



Macron Associate Co. – Power Supply Team

NO.352, Peng-Yi Road, Taiping, Taichung, Taiwan 411

TEL: 886-4-22708357 FAX: 886-4-22767307 Email: macron@macrongroup.com

B0618

Input - specification

	Units	Minimum	Typical	Maximum	Notes
Input Voltage Range(Vin)	Vac	108	120-277	304	
Input Frequency Range	Hz	50	60	63	
Input Power	W		27		
Power Factor(PF)		0.9	>0.9		>80% Load
Input Current	A	-	-	0.23A@120VAC 0.01A@277VAC	
Inrush Current	A			4 A peak	According to IEC 60555
Total Harmonics Distortion (THD)				20%	1. At nominal input voltage and nominal LED voltage 2. Measure at full load
Efficiency		-	>80%	-	Efficiency is measured after driver has thermally stabilized + full load
Isolation	Meet UL1310/UL8750 for class 2 isolation power supply				

Output - specification

	Units	Minimum	Typical	Maximum	Notes
Output Voltage(V out)	Vdc	36		42	
Output Current(I out)	mA		300/400/450 /550		
Output Current Tolerance	%		±3		
Output Ripple Current		<20% peak-to-peak of 550mA			$\leq 20\%$ pk-to-pk of the rated output current for all models with Vout max $\geq 32V$ $\leq 50\%$ pk-to-pk of the rated output current for all models with Vout max $\leq 30V$ At nominal LED voltage and nominal input voltage without dimming
Dimming Range	%	3%		100%	Please refer to Dimmer compatibility list
Start-up Time	ms		250		With nominal LED voltage and without dimmer attached
			300		With nominal LED voltage, with an recommended dimmer attached(see dimmer compatibility list) and at the full dimming conduction angle
Operation Case Temperature	°C	-30		80C	
Isolation	Meet UL1310/UL8750 for class 2 isolation power supply				

EMC / Protection / Compliance

Conducted and Radiated EMI		FCC CFR Title 47 Part 15 Class B and EN55022(CISPR 22) Class B compliant			
Immunity Compliance	ESD (Electrostatic Discharge)	IEC61000-4-2	6 kV contact discharge, 8 kV air discharge, level 3		
	Electrical Fast Transient	IEC61000-4-4	±2 kV on AC power port for 1 minute, ±1kV on signal/control lines		
	Surge	IEC61000-4-5	±1kV line to line/±2kV line to earth on AC power port, ±0.5kV for outdoor cables		
Transient Protection	Ring Wave		ANSI/IEEE c62.41-1-2002 & c62.41-2-2002 category A, 2.5kV ring wave		

THD of the driver VS Power Output (W) :

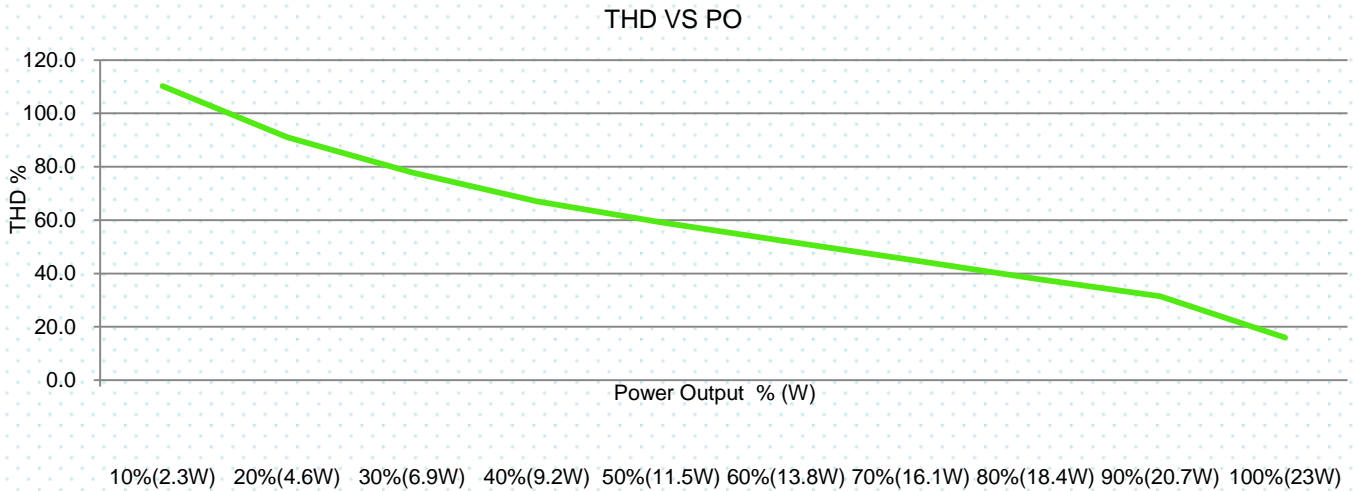

Efficiency of the driver VS Power Output (W) :

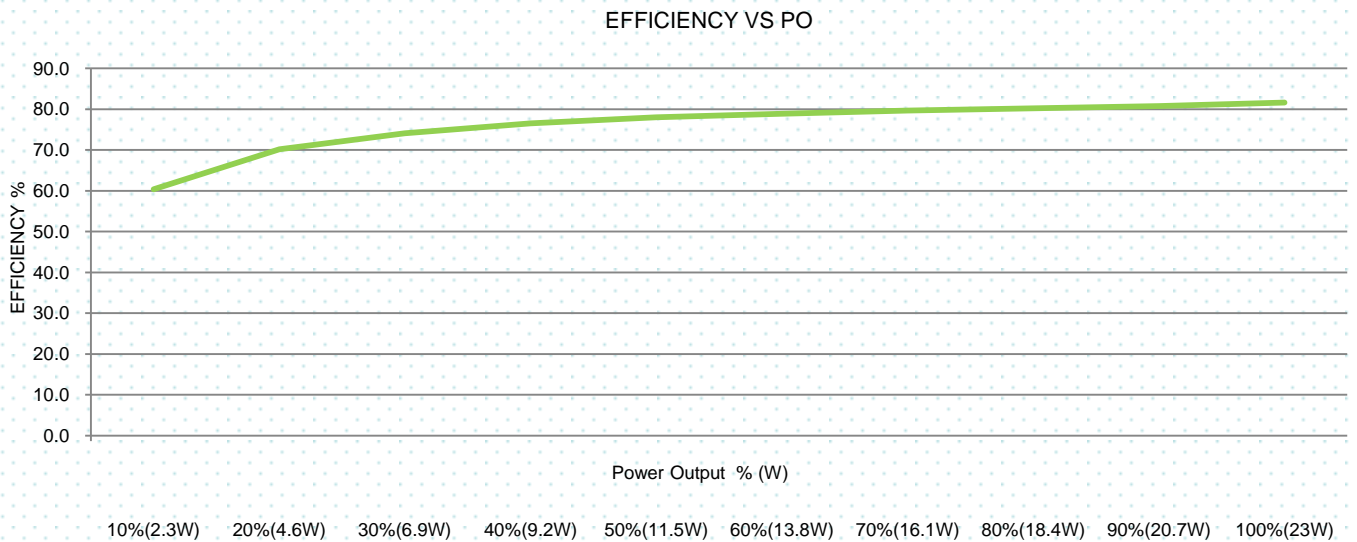

Macron Associate Co. – Power Supply Team

NO.352, Peng-Yi Road, Taiping, Taichung, Taiwan 411

TEL: 886-4-22708357 FAX: 886-4-22767307 Email: macron@macrongroup.com

B0618

Electrical Specifications

Efficiency of the driver VS Power Output (W) :

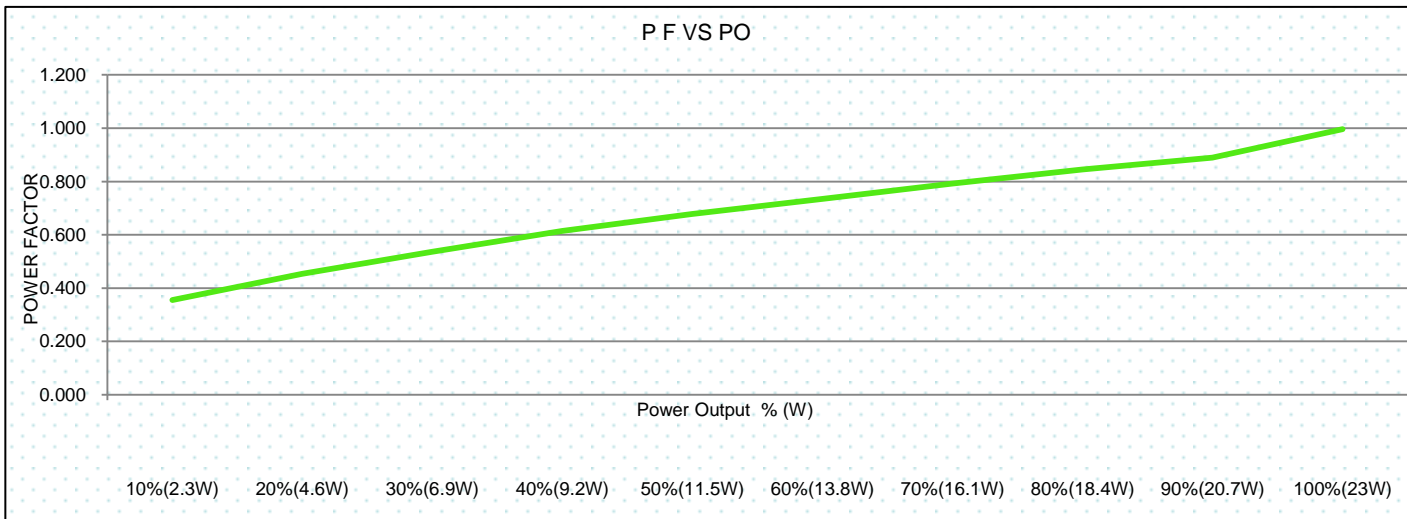

Current Settings :

LED Current Tolerance over temperature and component variations is $\leq 5\%$ at any level.

The output current of the driver can be adjusted using the two dip switches provided on the top of the driver. The below pictures shows the switch positions required to set the current to different levels.

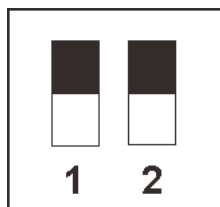

ON
300mA

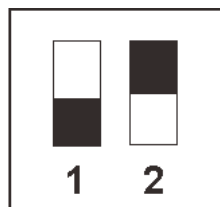

ON
400mA



ON
450mA

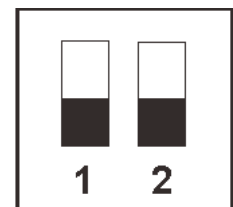

ON
550mA

The driver will be shipped out of factory with both switches set to ON (550mA).



Macron Associate Co. – Power Supply Team

NO.352, Peng-Yi Road, Taiping, Taichung, Taiwan 411

TEL: 886-4-22708357 FAX: 886-4-22767307 Email: macron@macrongroup.com

B0618